

Soluzione in sacchetto - Plastic bag solution - Sachets en plastiques - Solución en Bolsa

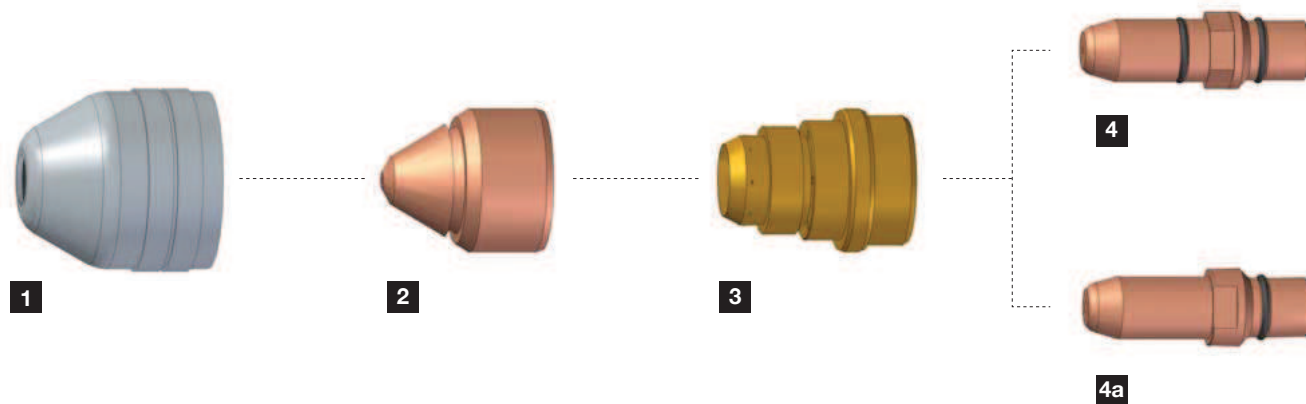



OCP 150 - O₂(OCP 150 - O₂ torch)

CODE		A	Ø 0,7	Ø 0,8	Ø 1,0	Ø 1,3	Ø 1,6	REF	Pcs X 
------	--	---	-------	-------	-------	-------	-------	-----	---



1 SCHERMO STANDARD - STANDARD SHIELD - PATIN STANDARD - ESCUDO ESTÁNDAR

PC0040								0409-2166	2
--------	---	--	--	--	--	--	--	-----------	---

2 CAPPÀ - NOZZLE - TUYÈRE - BOQUILLA

PD0086-07		30	•					0409-2173	10
PD0086-08		40		•				0409-2174	10
PD0086-10		60			•			0409-2176	10
PD0086-13		90				•		0409-2183	10
PD0086-16		120					•	0409-2186	10

3 DIFFUSORE - SWIRL RING - DIFFUSEUR - DIFFUSOR

PE0040		60						0409-2170	2
PE0041		120						0409-2169	2

4 ELETTRODO - ELECTRODE - ELECTRODE - ELECTRODO

PR0073								0409-2184	10
--------	---	--	--	--	--	--	--	-----------	----

4a ELETTRODO - ELECTRODE - ELECTRODE - ELECTRODO

PR0075								0409-2185	10
--------	---	--	--	--	--	--	--	-----------	----