

## Soluzione in sacchetto - Plastic bag solution - Sachets en plastiques - Solución en Bolsa

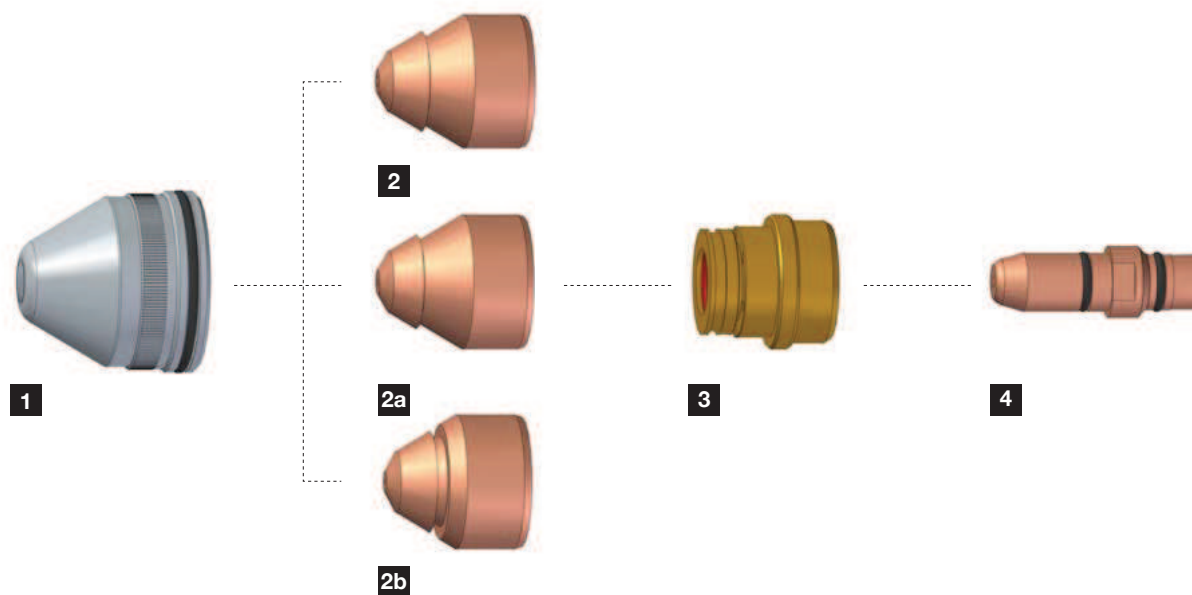

OCP 150 - N<sub>2</sub>-Ar/H<sub>2</sub>(OCP 150 - N<sub>2</sub>-Ar/H<sub>2</sub> torch)

CODE		A	Ø 0,8	Ø 1,0	Ø 1,2	Ø 1,3	Ø 1,6	REF	Pcs X 
------	--	---	-------	-------	-------	-------	-------	-----	---



#### 1 SCHERMO STANDARD - STANDARD SHIELD - PATIN STANDARD - ESCUDO ESTÁNDAR

PC0170								0409-2210	2
--------	---	--	--	--	--	--	--	-----------	---



#### 2 CAPPÀ - NOZZLE - TUYÈRE - BOQUILLA

PD0170-08		40	•					0409-2234	10
PD0170-10		60		•				0409-2236	10

#### 2a CAPPÀ - NOZZLE - TUYÈRE - BOQUILLA

PD0171-13		90			•			0409-2239	10
PD0171-16		120					•	0409-2240	10

#### 2b CAPPÀ - NOZZLE - TUYÈRE - BOQUILLA

PD0172-13		90				•		0409-2249	10
PD0172-16		120					•	0409-2250	10

#### 3 DIFFUSORE - SWIRL RING - DIFFUSEUR - DIFFUSOR

PE0170		60						0409-2209	2
--------	---	----	--	--	--	--	--	-----------	---

#### 4 ELETTRODO - ELECTRODE - ELECTRODE - ELECTRODO

PR0170								0409-2194	10
--------	---	--	--	--	--	--	--	-----------	----